



# **KARATAY**

**INSTRUCTIONS MANUAL**

**Model 612 TAC**



**READ THE INSTRUCTIONS AND WARNINGS IN THIS MANUAL CAREFULLY BEFORE USING THIS FIREARM**

**FIREARMS SAFETY**

We believe that safe firearms handling is the most important consideration for anyone who uses firearms and ammunition. Please take a few minutes to thoroughly read and understand this instruction manual included with this shotgun.

**CAUTION**

**FIREARMS SAFETY DEPENDS ON YOU!**

- Don't rely on your gun's safety. Treat every gun as if were loaded and ready to fire.
- Never cross a fence, climb a tree or jump a ditch with a loaded gun.
- Never load or carry a loaded gun until you intend to use it.
- Watch your muzzle so the other fellow doesn't have to.
- Keep guns and ammunition separately and in locked storage.
- Don't shoot unless absolutely sure of your target and what is beyond it.
- Know the range of your gun.
- Always wear eye and ear protection when shooting.
- Always be sure the barrel is free of obstructions, and only carry ammunition specifically intended for the gun you are using.
- Do not alter or modify your gun. Have your gun regularly checked by a gunsmith.

**THIS MANUAL CONTAINS**

**SAFE GUN HANDLING IS YOUR PERSONAL RESPONSIBILITY AT ALL TIMES. Disregarding warnings in this manual may result in injury or death to you and others and damage to property.**

1. Important warnings that should be read and understood before using this firearm.
2. Directions and procedures for handling, loading, firing and unloading.
3. Instructions for care, cleaning, repair, and service of this shotgun.

This instruction and safety manual is designed to help you in learning how to properly use and care for your shotgun. Only when you are certain you have fully familiarized yourself with the function of your firearm should you practice loading, unloading and firing with live rounds of ammunition.

**This instruction manual should always accompany this firearm and be transferred with it upon change of ownership. Should you ever need to replace it, this manual is available FREE upon request.**

**DISCLAIMER OF LIABILITY**

We shall not be responsible for product malfunctioning or for physical injury, death or damage to property resulting from either intentional or accidental discharge of this firearm, its criminal or negligent use, improper or careless handling, unauthorized modifications or alteration, use of defective or improper or hand-loaded or (replaced) ammunition, or from its use for purposes or subject to treatment for which it was not designed. For your safety, use only original high quality commercially manufactured ammunition in good condition that is appropriate to the caliber / gauge of your gun. We shall not be responsible for products or results from use of defective, improper or reloaded ammunition.

**WARNING - LEAD EXPOSURE**

Discharging firearms in poorly ventilated areas, cleaning firearms, or handling ammunition may result in exposure to lead and other substances that may cause birth defects, reproductive harms, and other serious physical injuries. Have adequate ventilation at all times. Wash your hands thoroughly after exposure. Shooting or cleaning guns may expose you to lead.

**WARNING**

Prior to removing this gun from its packaging and prior to loading and firing, carefully and thoroughly read the entire instruction manual which gives advice on the gun's proper handling and functioning. Your safety and that of others (including your family) depends on your responsible compliance with that advice. If unfamiliar with firearms, seek supervised instruction.

**FIREARMS SAFETY IS YOUR RESPONSIBILITY.**

## GENERAL SAFETY WARNINGS

1. Careless and improper handling of this gun could result in unintended discharge causing injury, death or property damage. Safety must be the first and constant consideration when handling a firearm and ammunition.
2. This shotgun was designed to function properly in its original condition. Alterations can make it unsafe. Do not alter any part or add or replace parts.
3. Shotguns should only be carried with the action open and chamber empty to prevent accidental discharge.
4. Always handle and treat your gun as if it were loaded so you never fire it accidentally when you think it is unloaded. Never take anyone's word it is unloaded. Always check it yourself with your fingers off the trigger and the gun pointed in a safe direction.
5. Never place your finger inside the trigger guard unless you intend to fire.
6. Water, snow, mud, excessive lubricating oil or grease or any other material can obstruct the barrel of your gun. Always check the barrels of your firearm for obstruction before loading and firing. Clean a fouled gun immediately to ensure its correct and safe function.
7. Keep the gun's muzzle pointed in a safe direction at all times. Never let the muzzle of a firearm point at any part of your body, another person or at anything you do not intend to shoot. Always be certain of your target before firing.
8. UNLOAD ALL FIREARMS WHEN NOT IN USE. NEVER STORE A LOADED FIREARM. Firearms and ammunition should be safely stored separately so that they are inaccessible to children or unauthorized users.
9. Always make sure your gun is not loaded before cleaning, storing, or handing it to another person.

10. Always wear safety glasses while shooting to protect your eyes from injury by gun powder, gas, lubricant, dirt or metallic particles, carbon residue, sparks or other debris.
11. Always wear ear protection when shooting, especially on a range. Without ear protection the noise from your gun and other guns close to you, could leave a "ringing" in the ears for some time after firing. Repeated exposure to shooting noise could result in permanent hearing loss.
12. Never climb a tree, fence or wall while carrying a loaded firearm.
13. Don't shoot at a hard surface or water. A ricochet may travel in unpredictable directions to strike you or an object you cannot see.

14. Firearms and alcohol do not mix. Never drink alcoholic beverages or take drugs before or during shooting, as this constitutes criminal disregard for your safety and that of others. Never use a gun while you are taking medication unless you have checked with your doctor to ensure your fitness to handle your gun safely.
15. If you have any doubts about your ability to handle or use this shotgun safely, seek supervised instruction.
16. Horseplay has no place around firearms. Guns can't think - you can!
17. Remember, safety is your responsibility. Be a safe shooter.
18. FOLLOW THE LAW: Obey all local, state and federal laws regarding storage, shooting and transporting your firearm.

## NOMENCLATURE

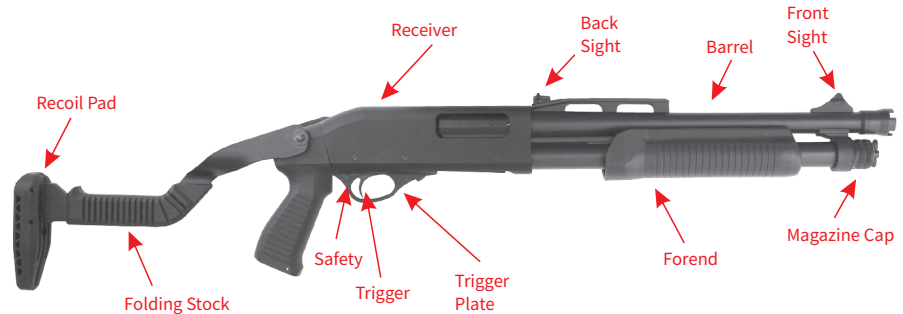

## UNPACKING YOUR SHOTGUN

Your shotgun is supplied in an individual carton, assembled and ready to use, as shown in (Fig.1).



Fig.1

## FOLDING STOCK

Press the stock button to release shotgun's stock from its position (Fig.2).



Fig.2

Fold the stock over the top of the stock pad in a horizontal position to the shotguns as shown in (Fig.3) (changing the position from a to b). When you want to unfold the stock, first change the stock pad position b to a. If the stock pad is not in position a then the button can not be worked. Next push the stock button and unfold the stock to the extended position. See that button is locked.

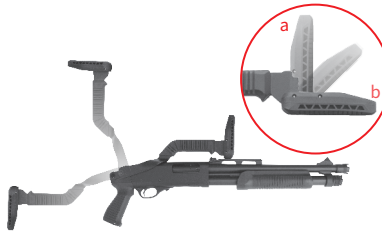

Fig.3

Your shotgun can be fired with the stock in folded position. The folded stock makes carrying easier (Fig.4).



Fig.4

## CAUTION

Do not load your shotgun until you are ready to use it and unload it immediately after you have finished shooting. Always carry your shotgun with the safety engaged. The user of this shotgun, and all firearms, should never depend on the manual safety, or any other mechanical device, to make a firearm completely safe. It is your responsibility to always keep the muzzle of your firearm pointed in a safe direction.

## OPERATING INSTRUCTIONS

**WARNING: READ AND UNDERSTAND ALL INSTRUCTIONS AND WARNINGS IN THIS MANUAL BEFORE USING THIS SHOTGUN. IT IS IMPORTANT TO LEARN THE PARTS OF YOUR SHOTGUN AND THEIR FUNCTIONS BEFORE USING THIS FIREARM.**

## MANUAL SAFETY

Your shotgun is equipped with a manual trigger block safety button located in the trigger guard, just behind the trigger (Fig.5). When the button is pushed from the left side of the receiver, protruding to the right side, the trigger is blocked and the safety is on.



Fig.5

When the button is pushed from the right side of the receiver, protruding to the left side, you will see a red circle on the safety button indicating the safety is off and the shotgun is in an unsafe condition, ready to fire if the trigger is pulled, as shown in (Fig.6). The directions are opposite for left hand shotguns.



Fig.6

## CAUTION

The manual safety of your shotgun should always be on except for when you are ready to pull the trigger and fire the shotgun. This will help insure that no accidental discharges take place. You should only have the safety off, and be able to see the red line on the left side of the receiver, when you are ready to shoot. (The directions are opposite for left hand shotguns.)

## AMMUNITION

Each pump action shotgun is clearly marked with the gauge and maximum length cartridge that may be used in that particular model.

The use of reloaded or substandard commercially produced ammunition will affect your warranty coverage and could result in severe injury to the shooter or others nearby. See the enclosed warranty registration card for any exclusions and limitations of our warranty.

Gauge & Chamber	Shells can be used
12/76 12Ga 3"	12/70 12Ga 2 3/4" 12/76 12Ga 3"

**Do not use a cartridge that is longer than the maximum cartridge length that is stamped on the barrel.**

## ADJUSTING THE BACK SIGHT

Back sight has one screw. The screw adjust up and down. Use a suitable star type screwdriver for this adjustment (Fig.7).

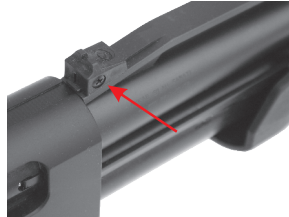

Fig.7

## LOADING

When loading, keep the safety on at all times and keep the muzzle pointed in a safe direction.

To load the magazine, turn the shotgun upside down. Insert your cartridge and push it into the magazine tube until it is held in place in the tube by the cartridge latch. As you insert each cartridge you will hear a "click" that tells you the latch has closed behind the cartridge and you can now load the next shell (Fig.8).



Fig.8

Note: Your shotgun is equipped with a plug that limits the number of cartridges that your magazine tube will hold to 2 shells. Removal and installing of the plug is shown in this manual in the DISASSEMBLY section.

Cycle the action by first pulling the forend toward the action and then pushing the forend forward until the action locks closed. Your shotgun is now in battery (Fig.9).

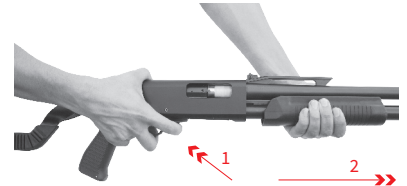

Fig.9

Your shotgun is now loaded and ready to fire if the safety is moved to the OFF position.

## FIRING

Keep the muzzle pointed at your target. Be aware of what is behind or around your target as well as the target itself. After you have cycled the action and loaded a shell into your pump shotgun, the gun is ready to fire. Depress the safety so that it is flush with the right side of the trigger guard and has been disengaged. Pull the trigger and the shotgun will fire. Cycle the action to eject the spent shell and reload another shell.

## UNLOADING

Before unloading, make sure the safety is in the ON position. And keep the muzzle pointed in a safe direction. Never allow your fingers or another object to come in contact with the trigger during unloading.

If you have your shotgun loaded and are ready to fire, but change your mind, first engage the safety by pushing the safety button flush with the left side of the trigger guard so that the red ring is no longer visible. Push the action release inward to unlock the action and slide the forend toward the action (Fig.10)



Fig.10

If you want to unload without pumping; turn your gun and press the carrier, press the latch which is the right side of the receiver. The shell, which had been loaded, will eject (Fig.11). Unload the shells by pressing the latch for every one. Be careful not to allow the shot shell to eject onto a hard surface, which may cause the shell to discharge.

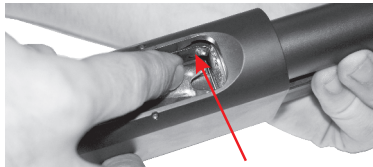

Fig.11

## DISASSEMBLY

Before disassembling your shotgun, be absolutely certain that it is unloaded. As an added precaution, visually check the chamber and the magazine tube for any cartridges. Put the safety in the on position.

1. Remove the magazine tube cap by unscrewing it counter clockwise (Fig.12).



Fig.12

2. Remove the barrel by pulling it out of the action (Fig.13).



Fig.13

3. Remove the forend and action bar assembly (Fig.14).



Fig.14

4. Remove the block from the action bar assembly (Fig.15-16).

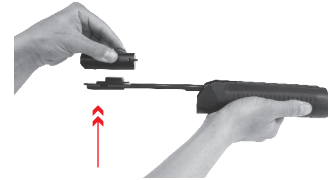

Fig.15



Fig.16

5. The trigger group may be removed from the receiver for further cleaning of the receiver and trigger group. It is recommended that a thorough cleaning be performed every 300 rounds.

To remove the trigger group, first remove the two trigger group retaining pins by using a punch to drive the pins out of the receiver (Fig.17).

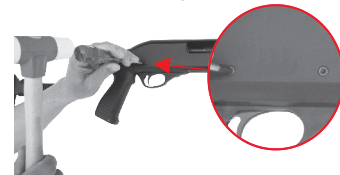

Fig.17

6. Once the retaining pins are removed, the entire trigger group can be removed from the receiver by pulling down on the trigger guard (Fig.18).



Fig.18

No further disassembly of the trigger group is recommended for anyone other than a trained gunsmith.

7. When reinstalling the trigger group, the hammer must be in its cocked position. To cock the hammer, pull down on the hammer with your thumb until it locks into place as shown in (Fig.19).

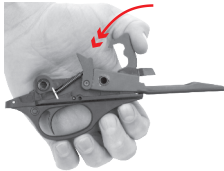

Fig.19

## MAGAZINE CAPACITY PLUG

Your shotgun is supplied with a plug to limit the capacity of cartridges in the magazine tube. Your country's regulations may not require this plug to be used so it may be removed.

When the barrel is removed from the shotgun, hold the magazine spring retainer with one of hand and push it down gently. With the other hand, press in the slot on the magazine tube with a screwdriver and push it upwards (Fig.20).

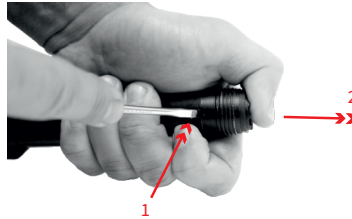

Fig.20

Be careful at this point, as the retainer holds a spring inside of the magazine tube and the spring is under tension. To replace the retainer plug, align the tab on the plug so that it clicks into place and push.

Your shotgun has now been completely disassembled. No further disassembly of your shotgun is necessary for routine maintenance and cleaning. Our service department or a competent gunsmith should only perform any further disassembly.

An exploded view of the disassembled shotgun is shown in (Fig.21).

Note: Photographs shown in this manual may not be from the exact model that you have but the instructions will apply to the model you have.

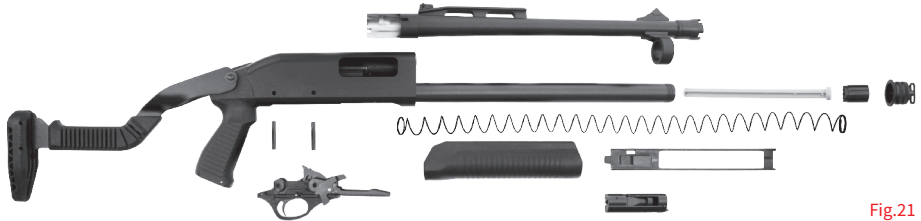

Fig.21

## ASSEMBLY

1. Take stock receiver assembly. Insert magazine spring, magazine capacity plug (if necessary) and magazine spring retainer following the instructions in disassembly section. Install trigger assembly to receiver. Be careful hammer is cocked. Insert trigger plate pins. Install breech bolt onto action bar and action bar to forend referring figures 15-20.

2. Move the forend reward slightly, so that the bolt is in the locked position (Fig. 22).

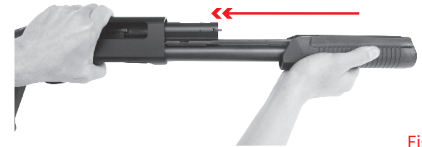

Fig.22

Install the bolt on the action bar as shown on (Fig.22a and 22b). Be sure the action bar plunger pin stays inside bolt.

**WARNING: IT WILL CAUSE JAMMING IF THE BOLT STAYS ON THE ACTION BAR PLUNGER PIN**



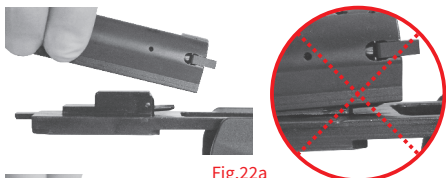

Fig.22a

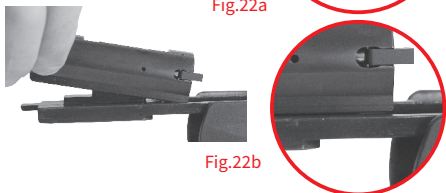

Fig.22b

3. Insert the barrel extension into the receiver, making sure that the barrel extension is sliding between the bolt and top of the receiver and that the barrel collar is surrounding the magazine tube. Push the barrel back into the receiver until the barrel extension is flush with the front of the receiver (Fig 23-24).

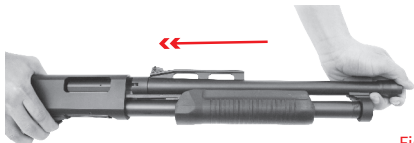

Fig.23



Fig.24

4. Reattach the magazine cap to the magazine tube by rotating it in a clockwise direction until it is firmly screwed down against the forend as shown in (Fig.25).

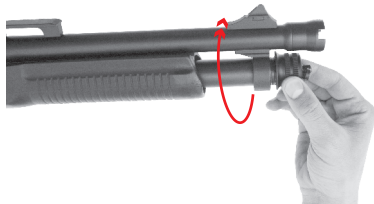

Fig.25

5. Press release button to unlock the bolt (Fig.26).

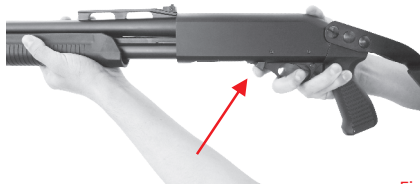

Fig.26

6. Move forend fully backward and forward (pumping) (Fig.27).



Fig.27

Repeat the steps 7 and 8 a few times to check the assembly is done properly.

## CLEANING AND STORAGE

After extended shooting sessions, it will be necessary to clean your shotgun. Semi-auto shotguns require more cleaning than any other type of shotgun, because of their gas operated construction.

Periodically, clean the bore with proper cleaning equipment. Oil all metal surfaces lightly with high quality gun oil. Never pour oil into any inside mechanisms.

If you will be storing your shotgun for long periods of time, apply gun grease to all metal parts, store the shotgun in a dry, and secure area. When you clean the shotgun, make sure the muzzle is not plugged with any heavy grease that would cause a barrel obstruction.

## SERVICE INSTRUCTIONS

If your shotgun does require service, contact our local service department by e-mail, letter, fax or telephone. If you should ever have to send your shotgun back for repair please follow these instructions:

- Make absolutely certain it is unloaded;
- Do not send ammunition with your shotgun;
- Remove any accessories;
- Please package the gun securely (be certain gun parts can not shift during shipment) in a suitable shipping container;
- Please include, with your firearm, a clear description of the problem and service you wish us to perform;
- Please give us a clear ship-to address, (no P.O. Box numbers) your daytime phone number and if possible a fax number and email address;
- Please place your correspondence inside the package;
- If you have any questions, please contact the service department, at;

# MODEL 612 TAC PUMP SHOTGUN PART DIAGRAM

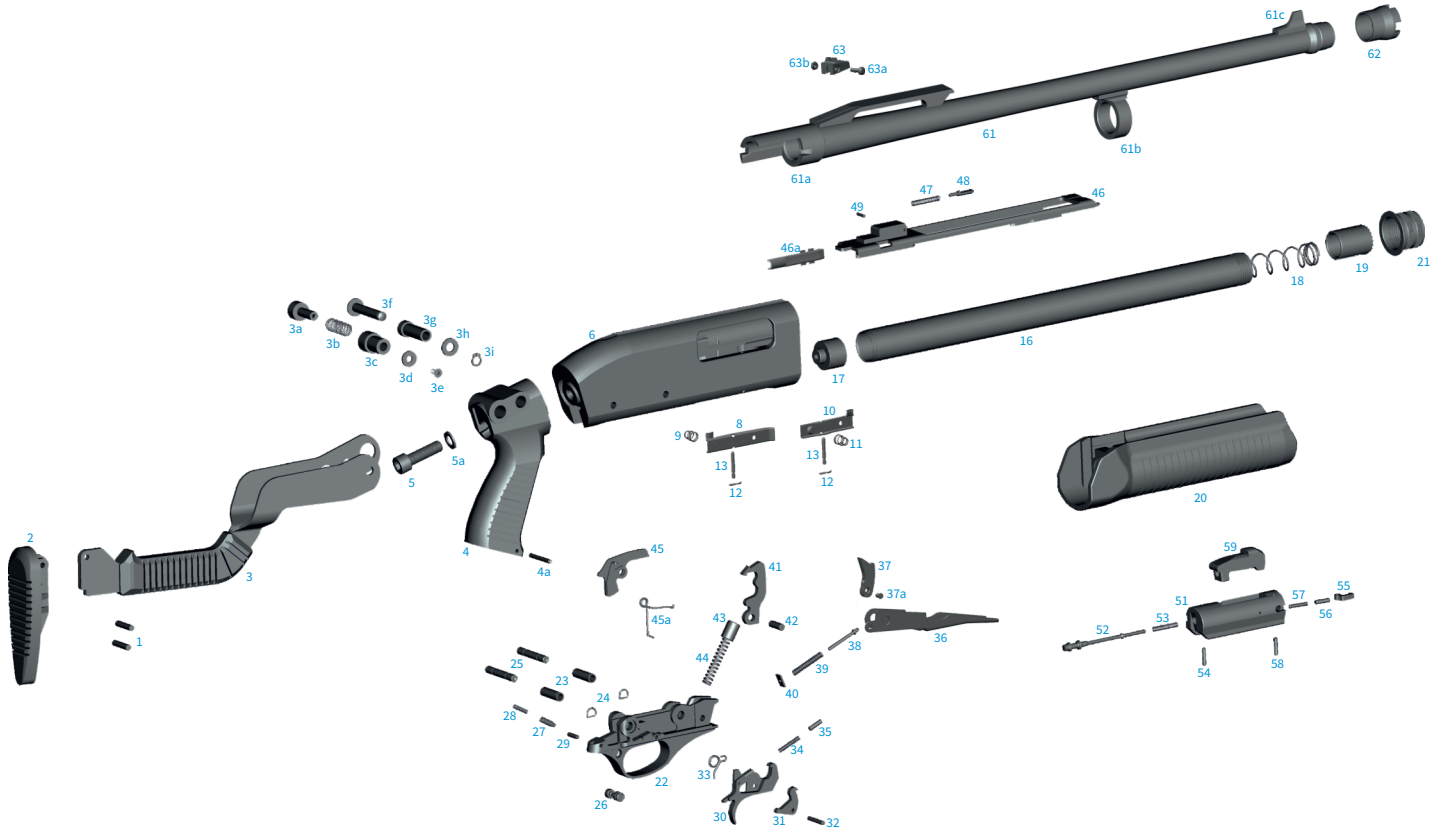

## MODEL 612 TAC PUMP SHOTGUN PART LIST

No	Part Name	No	Part Name	No	Part Name
1	Recoil Pad Screw (x2)	19	Magazine Spring Retainer	44	Hammer Spring
2	Recoil Pad	20	Forend	45	Action Release
3	Folding Stock	21	Magazine Cap	45a	Release Latch Spring
3a	Button	22	Trigger Plate	46	Action Bar
3b	Button Spring	23	Trigger Plate Pin Bushing (x2)	46a	Ejector
3c	Button Bushing	24	Trigger Plate Pin Detent Spring (x2)	47	Action Bar Plunger Spring
3d	Washer	25	Trigger Plate Pin (x2)	48	Action Bar Plunger
3e	Screw	26	Safety Button	49	Action Bar Plunger Retaining Pin
3f	Main Pin	27	Safety Button Detent Pin	51	Breech Bolt
3g	Main Pin Bushing	28	Safety Button Spring	52	Firing Pin
3h	Washer	29	Safety Spring Retaining Pin	53	Firing Pin Spring
3i	Detent Spring	30	Trigger	54	Firing Pin Retaining Pin
4	Pistol Grip	31	Trigger Sear	55	Extractor
4a	Stock Sling Swivel Stud	32	Trigger Pin	56	Extractor Plunger
5	Stock Screw	33	Trigger Spring	57	Extractor Spring
5a	Stock Screw Washer	34	Trigger Sear Detent Spring	58	Extractor Pin
6	Receiver	35	Trigger Sear Detent Pin	59	Locking Block
8	Latch	36	Carrier	61	Barrel
9	Latch Spring	37	Carrier Dog	61a	Barrel Rear Part
10	Interceptor Latch	37a	Carrier Dog Pin	61b	Barrel Collar
11	Interceptor Latch Spring	38	Carrier Dog Follower	61c	Front Sight
12	Latch Pin Detent Spring (x2)	39	Carrier Dog Follower Spring	62	Muzzle Cap
13	Latch Pin (x2)	40	Carrier Dog Follower Plate	63	Adjusted Back Sight Base
16	Magazine Tube	41	Hammer	63a	Adjusted Back Sight Screw
17	Magazine Follower	42	Hammer Pin	63b	Adjusted Back Sight Nut
18	Magazine Spring	43	Hammer Plunger		



## AKKAR SİLAH SANAYİ LTD

ORHANLI MH ANIT SK 21 TUZLA 34956 İSTANBUL TURKEY

**P** +90 216 394 43 64 **F** +90 216 394 43 73

AKKAR@AKKAR.COM.TR WWW.AKKAR.COM.TR



//AKKARSILAH



@AKKARSILAH



//AKKARSILAH

HMC.KLV.POMP.009-00