



KARATAY

INSTRUCTIONS MANUAL

Models 612-612 TAC-620-628-636

READ THE INSTRUCTIONS AND WARNINGS IN THIS MANUAL CAREFULLY BEFORE USING THIS FIREARM

FIREARMS SAFETY

We believe that safe firearms handling is the most important consideration for anyone who uses firearms and ammunition. Please take a few minutes to thoroughly read and understand this instruction manual included with this shotgun.

CAUTION

FIREARMS SAFETY DEPENDS ON YOU!

- Don't rely on your gun's safety. Treat every gun as if were loaded and ready to fire.
- Never cross a fence, climb a tree or jump a ditch with a loaded gun.
- Never load or carry a loaded gun until you intend to use it.
- Watch your muzzle so the other fellow doesn't have to.
- Keep guns and ammunition separately and in locked storage.
- Don't shoot unless absolutely sure of your target and what is beyond it.
- Know the range of your gun.
- Always wear eye and ear protection when shooting.
- Always be sure the barrel is free of obstructions, and only carry ammunition specifically intended for the gun you are using.
- Do not alter or modify your gun. Have your gun regularly checked by a gunsmith.

THIS MANUAL CONTAINS

SAFE GUN HANDLING IS YOUR PERSONAL RESPONSIBILITY AT ALL TIMES. Disregarding warnings in this manual may result in injury or death to you and others and damage to property.

1. Important warnings that should be read and understood before using this firearm.
2. Directions and procedures for handling, loading, firing and unloading.
3. Instructions for care, cleaning, repair, and service of this shotgun.

This instruction and safety manual is designed to help you in learning how to properly use and care for your shotgun. Only when you are certain you have fully familiarized yourself with the function of your firearm should you practice loading, unloading and firing with live rounds of ammunition.

This instruction manual should always accompany this firearm and be transferred with it upon change of ownership. Should you ever need to replace it, this manual is available FREE upon request.

DISCLAIMER OF LIABILITY

We shall not be responsible for product malfunctioning or for physical injury, death or damage to property resulting from either intentional or accidental discharge of this firearm, its criminal or negligent use, improper or careless handling, unauthorized modifications or alteration, use of defective or improper or hand-loaded or (replaced) ammunition, or from its use for purposes or subject to treatment for which it was not designed. For your safety, use only original high quality commercially manufactured ammunition in good condition that is appropriate to the caliber / gauge of your gun. We shall not be responsible for products or results from use of defective, improper or reloaded ammunition.

WARNING - LEAD EXPOSURE

Discharging firearms in poorly ventilated areas, cleaning firearms, or handling ammunition may result in exposure to lead and other substances that may cause birth defects, reproductive harms, and other serious physical injuries. Have adequate ventilation at all times. Wash your hands thoroughly after exposure. Shooting or cleaning guns may expose you to lead.

WARNING

Prior to removing this gun from its packaging and prior to loading and firing, carefully and thoroughly read the entire instruction manual which gives advice on the gun's proper handling and functioning. Your safety and that of others (including your family) depends on your responsible compliance with that advice. If unfamiliar with firearms, seek supervised instruction.

FIREARMS SAFETY IS YOUR RESPONSIBILITY.

GENERAL SAFETY WARNINGS

1. Careless and improper handling of this gun could result in unintended discharge causing injury, death or property damage. Safety must be the first and constant consideration when handling a firearm and ammunition.
2. This shotgun was designed to function properly in its original condition. Alterations can make it unsafe. Do not alter any part or add or replace parts.
3. Shotguns should only be carried with the action open and chamber empty to prevent accidental discharge.
4. Always handle and treat your gun as if it were loaded so you never fire it accidentally when you think it is unloaded. Never take anyone's word it is unloaded. Always check it yourself with your fingers off the trigger and the gun pointed in a safe direction.
5. Never place your finger inside the trigger guard unless you intend to fire.
6. Water, snow, mud, excessive lubricating oil or grease or any other material can obstruct the barrel of your gun. Always check the barrels of your firearm for obstruction before loading and firing. Clean a fouled gun immediately to ensure its correct and safe function.
7. Keep the gun's muzzle pointed in a safe direction at all times. Never let the muzzle of a firearm point at any part of your body, another person or at anything you do not intend to shoot. Always be certain of your target before firing.
8. UNLOAD ALL FIREARMS WHEN NOT IN USE. NEVER STORE A LOADED FIREARM. Firearms and ammunition should be safely stored separately so that they are inaccessible to children or unauthorized users.
9. Always make sure your gun is not loaded before cleaning, storing, or handing it to another person.

10. Always wear safety glasses while shooting to protect your eyes from injury by gun powder, gas, lubricant, dirt or metallic particles, carbon residue, sparks or other debris.
11. Always wear ear protection when shooting, especially on a range. Without ear protection the noise from your gun and other guns close to you, could leave a "ringing" in the ears for some time after firing. Repeated exposure to shooting noise could result in permanent hearing loss.
12. Never climb a tree, fence or wall while carrying a loaded firearm.
13. Don't shoot at a hard surface or water. A ricochet may travel in unpredictable directions to strike you or an object you cannot see.

14. Firearms and alcohol do not mix. Never drink alcoholic beverages or take drugs before or during shooting, as this constitutes criminal disregard for your safety and that of others. Never use a gun while you are taking medication unless you have checked with your doctor to ensure your fitness to handle your gun safely.

15. If you have any doubts about your ability to handle or use this shotgun safely, seek supervised instruction.

16. Horseplay has no place around firearms. Guns can't think - you can!

17. Remember, safety is your responsibility. Be a safe shooter.

18. FOLLOW THE LAW: Obey all local, state and federal laws regarding storage, shooting and transporting your firearm.

NOMENCLATURE

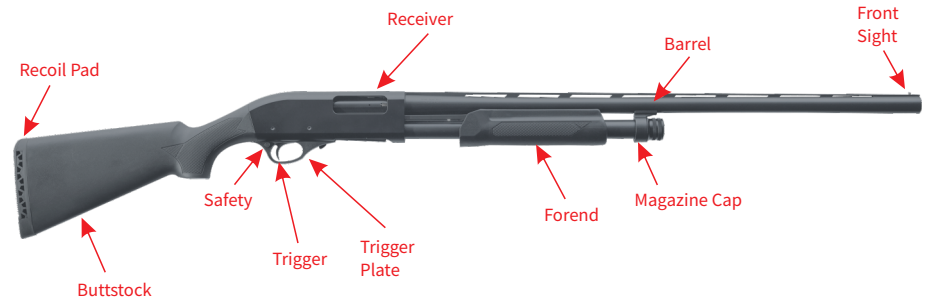

UNPACKING YOUR SHOTGUN

When you remove the shotgun from its box, you will see the 2 major components, the barrel and the shotgun (Fig.1). Your shotgun comes with a choke tube installed in the barrel along with a choke tube wrench if it is equipped with mobile chokes. A magazine capacity plug should be installed into the magazine or separately located. You should also have an instruction manual in the package.



Fig.1

ASSEMBLY

1. Unscrew the magazine cap from the front of the forend in a counter clockwise direction as shown in (Fig.2).

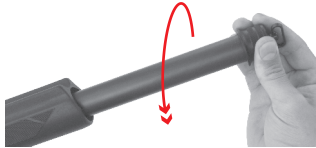

Fig.2

2. Move the forend reward slightly, so that the bolt is in the locked closed position (Fig.3).

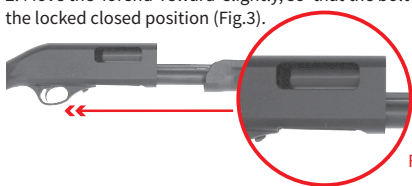

Fig.3

Install the bolt on the action bar as shown on (Fig.3a and 3b). Be sure the action bar plunger pin stays inside bolt.

WARNING: IT WILL CAUSE JAMMING IF THE BOLT STAYS ON THE ACTION BAR PLUNGER PIN

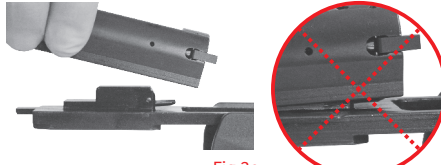

Fig.3a

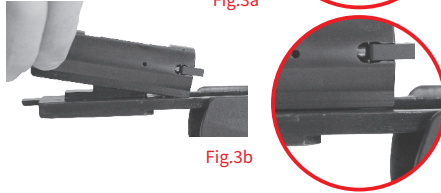

Fig.3b

3. Insert the barrel extension into the receiver, making sure that the barrel extension is sliding between the bolt and top of the receiver and that the barrel collar is surrounding the magazine tube. Push the barrel back into the receiver until the barrel extension is flush with the front of the receiver (Fig.4-5).

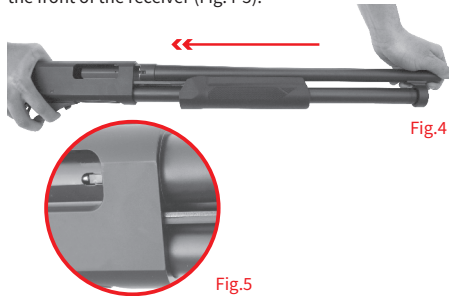

Fig.4

4. Reattach the magazine cap, screwing it down as tightly as possible (Fig.6).



Fig.6

The shotgun is now fully assembled.

5. Press release button to unlock the bolt (Fig.7).

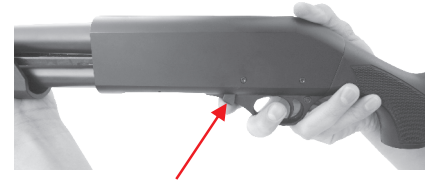

Fig.7

6. Move forend fully backward and forward (pumping) (Fig.8).

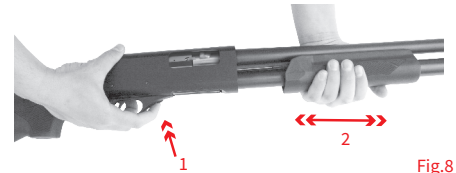

Fig.8

Repeat the steps 5 and 6 a few times to check the assembly is done properly.

CAUTION

Do not load your shotgun until you are ready to use it and unload it immediately after you have finished shooting. Always carry your shotgun with the safety engaged. The user of this shotgun, and all firearms, should never depend on the manual safety, or any other mechanical device, to make a firearm completely safe. It is your responsibility to always keep the muzzle of your firearm pointed in a safe direction.

OPERATING INSTRUCTIONS

WARNING: READ AND UNDERSTAND ALL INSTRUCTIONS AND WARNINGS IN THIS MANUAL BEFORE USING THIS SHOTGUN. IT IS IMPORTANT TO LEARN THE PARTS OF YOUR SHOTGUN AND THEIR FUNCTIONS BEFORE USING THIS FIREARM.

MANUAL SAFETY

Your shotgun is equipped with a manual trigger block safety button located in the trigger guard, just behind the trigger (Fig.9). When the button is pushed from the left side of the receiver, protruding to the right side, the trigger is blocked and the safety is on.



Fig.9

When the button is pushed from the right side of the receiver, protruding to the left side, you will see a red circle on the safety button indicating the safety is off and the shotgun is in an unsafe condition, ready to fire if the trigger is pulled, as shown in (Fig.10). The directions are opposite for left hand shotguns.



Fig.10

CAUTION

The manual safety of your shotgun should always be on except for when you are ready to pull the trigger and fire the shotgun. This will help insure that no accidental discharges take place. You should only have the safety off, and be able to see the red line on the left side of the receiver, when you are ready to shoot. (The directions are opposite for left hand shotguns.)

MULTI CHOKE TUBES

All pump action shotguns, except slug models, equipped with interchangeable multi choke tube. The notches on the top of the tube can identify the choke tube (Fig.11).

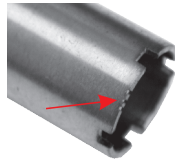

Fig.11

Multi-Choke Tube Markings and Constrictions

Name	Constriction Inch mm	Notches	Markings
Cylinder	.000" 0.00		C
Skeet	.005" 0.13		S
Improved Cylinder	.010" 0.25		IC
Modified	.020" 0.51		M
Improved Modified	.025" 0.64		IM
Full	.035" 0.89		F

WARNING: PERIODICALLY CHECK TO BE SURE THE CHOKE TUBES ARE TIGHT & PROPERLY SEATED.

Before changing a choke tube, always make sure that your shotgun is unloaded and the safety is in the "Safe" position. To change the choke tubes, use the choke tube wrench. The wrench and additional chokes are supplied in the shotgun box. Insert the wrench into the recessed space of the tube and unscrew counterclockwise. Insert the desired choke tube and seat with the wrench in the clockwise direction (Fig.12).



Fig.12

WARNING: NEVER FIRE YOUR SHOTGUN WITHOUT A CHOKE TUBE INSTALLED. This could damage the choke tube threads on the inside of the barrels.

AMMUNITION

Use only high quality factory ammunition specifically designed for your gauge of shotgun. The gauge and chamber are marked on barrel. The shells that can be used for each gauge are listed at below table. We do not recommend using slugs with choke tubes tighter than improved cylinder.

WARNING: STEEL SHOT USAGE

Your shotgun will accommodate steel shot. However steel shot (up to and including shot size #2) should not be fired through your shotgun with a choke tighter than modified. If shot larger than #2 is used, the tightest choke used should be an improved cylinder. Do not use steel shot with improved modified, full or extra full choke tubes (flush mount or external).

WARNING: ACCIDENTAL LOADING AND DISCHARGE OF SHELLS OF THE WRONG GAUGE IN YOUR GUN CAN RESULT IN DAMAGE TO YOUR GUN AND INJURY TO THE SHOOTER OR OTHERS.

Only carry the proper ammunition with you when shooting.

LOADING

When loading, keep the safety on at all times and keep the muzzle pointed in a safe direction.

Gauge & Chamber		Shells can be used					
12/76	12Ga 3"	12/70	12Ga 2 ¾"	12/76	12Ga 3"		
12/89	12Ga 3 ½"	12/70	12Ga 2 ¾"	12/76	12Ga 3"	12/89	12Ga 3 ½"
20/76	20Ga 3"	20/70	20Ga 2 ¾"	20/76	20Ga 3"		
28/70	28Ga 2 ¾"	28/70	28Ga 2 ¾"				

Do not use a cartridge that is longer than the maximum cartridge length that is stamped on the barrel.

Turn the shotgun upside down. Make sure the action is locked closed.

Place a shotshell, of the proper gauge, onto the carrier (Fig.13).



Fig.13

Slide the shell up and into the magazine tube. Two shells can fit into the magazine tube.

Cycle the action by first pulling the forend toward the action and then pushing the forend forward until the action locks closed. Your shotgun is now in battery (Fig.14).



Fig.14

You can increase the shot capacity of your shotgun by adding an additional shotshell into the magazine following the procedures above.

FIRING

Keep the muzzle pointed at your target. Be aware of what is behind or around your target as well as the target itself. After you have cycled the action and loaded a shell into your pump shotgun, the gun is ready to fire. Depress the safety so that it is flush with the right side of the trigger guard and has been disengaged. Pull the trigger and the shotgun will fire. Cycle the action to eject the spent shell and reload another shell.

UNLOADING

Before unloading, make sure the safety is in the ON position. And keep the muzzle pointed in a safe direction. Never allow your fingers or another object to come in contact with the trigger during unloading.

If you have your shotgun loaded and are ready to fire, but change your mind, first engage the safety by pushing the safety button flush with the left side of the trigger guard so that the red ring is no longer visible. Push the action release inward to unlock the action and slide the forend toward the action (Fig.15).



Fig.15

If you want to unload without pumping; turn your gun and press the carrier, press the latch which is the right side of the receiver. The shell, which had been loaded, will eject (Fig.16). Unload the shells by pressing the latch for every one. Be careful not to allow the shot shell to eject onto a hard surface, which may cause the shell to discharge.

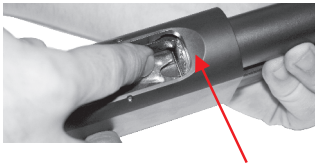

Fig.16

DISASSEMBLY

Before disassembling your shotgun, be absolutely certain that it is unloaded. As an added precaution, visually check the chamber and the magazine tube for any cartridges. Put the safety in the on position.

1. Remove the magazine cap (Fig.17).

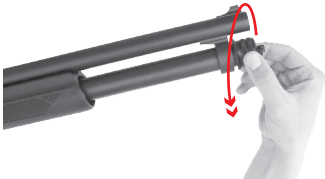

Fig.17

2. Remove the barrel by pulling it out of the action (Fig.18).



Fig.18

3. Remove the forend and action bar assembly (Fig.19).

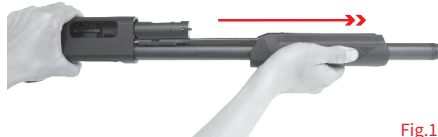

Fig.19

4. Remove the block from the action bar assembly (Fig.20-21).

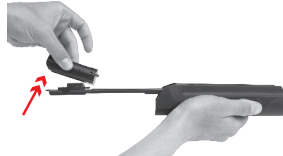

Fig.20

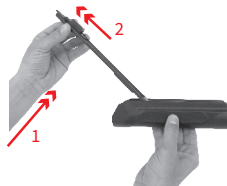

Fig.21

5. The trigger group may be removed from the receiver for further cleaning of the receiver and trigger group. It is recommended that a thorough cleaning be performed every 300 rounds.

To remove the trigger group, first remove the two trigger group retaining pins by using a punch to drive the pins out of the receiver (Fig.22).

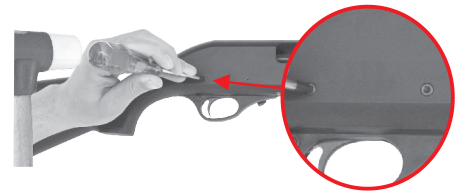

Fig.22

6. Once the retaining pins are removed, the entire trigger group can be removed from the receiver by pulling down on the trigger guard (Fig.23).



Fig.23

No further disassembly of the trigger group is recommended for anyone other than a trained gunsmith.

7. When reinstalling the trigger group, the hammer must be in its cocked position. To cock the hammer, pull down on the hammer with your thumb until it locks into place as shown in (Fig.24).

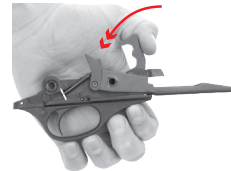

Fig.24

MAGAZINE CAPACITY PLUG

Your shotgun is supplied with a plug to limit the capacity of cartridges in the magazine tube. Your country's regulations may not require this plug to be used so it may be removed.

When the barrel is removed from the shotgun, hold the magazine spring retainer with one of hand and push it down gently. With the other hand, press in the slot on the magazine tube with a screwdriver and push it upwards (Fig.25).

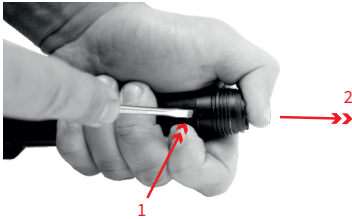

Fig.25

Be careful at this point, as the retainer holds a spring inside of the magazine tube and the spring is under tension. To replace the retainer plug, align the tab on the plug so that it clicks into place and push.

Your shotgun has now been completely disassembled. No further disassembly of your shotgun is necessary for routine maintenance and cleaning. Our service department or a competent gunsmith should only perform any further disassembly.

An exploded view of the disassembled shotgun is shown in (Fig.26).

Note: Photographs shown in this manual may not be from the exact model that you have but the instructions will apply to the model you have.

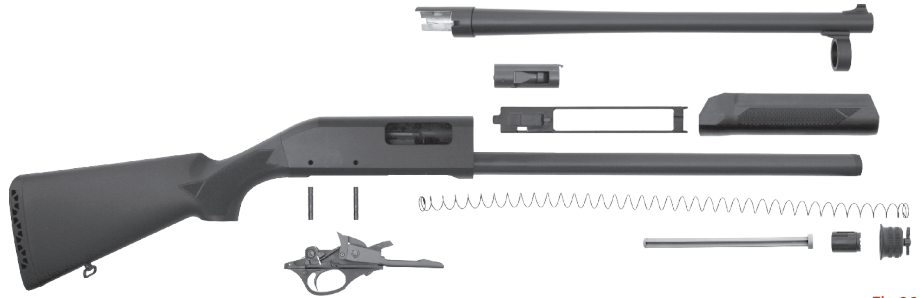

Fig.26

CLEANING AND STORAGE

Periodically, clean the bore with proper cleaning equipment. Oil all metal surfaces lightly with high quality gun oil. Never pour oil into any inside mechanisms.

If you will be storing your shotgun for long periods of time, apply gun grease to all metal parts, store the shotgun in a dry, and secure area. When you clean the shotgun, make sure the muzzle is not plugged with any heavy grease that would cause a barrel obstruction.

SERVICE INSTRUCTIONS

If your shotgun does require service, contact our local service department by e-mail, letter, fax or telephone. If you should ever have to send your shotgun back for repair please follow these instructions:

- a) Make absolutely certain it is unloaded;
- b) Do not send ammunition with your shotgun;
- c) Remove any accessories;
- d) Please package the gun securely (be certain gun parts can not shift during shipment) in a suitable shipping container;
- e) Please include, with your firearm, a clear description of the problem and service you wish us to perform;
- f) Please give us a clear ship-to address, (no P.O. Box numbers) your daytime phone number and if possible a fax number and email address;
- g) Please place your correspondence inside the package;
- h) If you have any questions, please contact the service department, at;

MODEL 612 PUMP SHOTGUN PART DIAGRAM

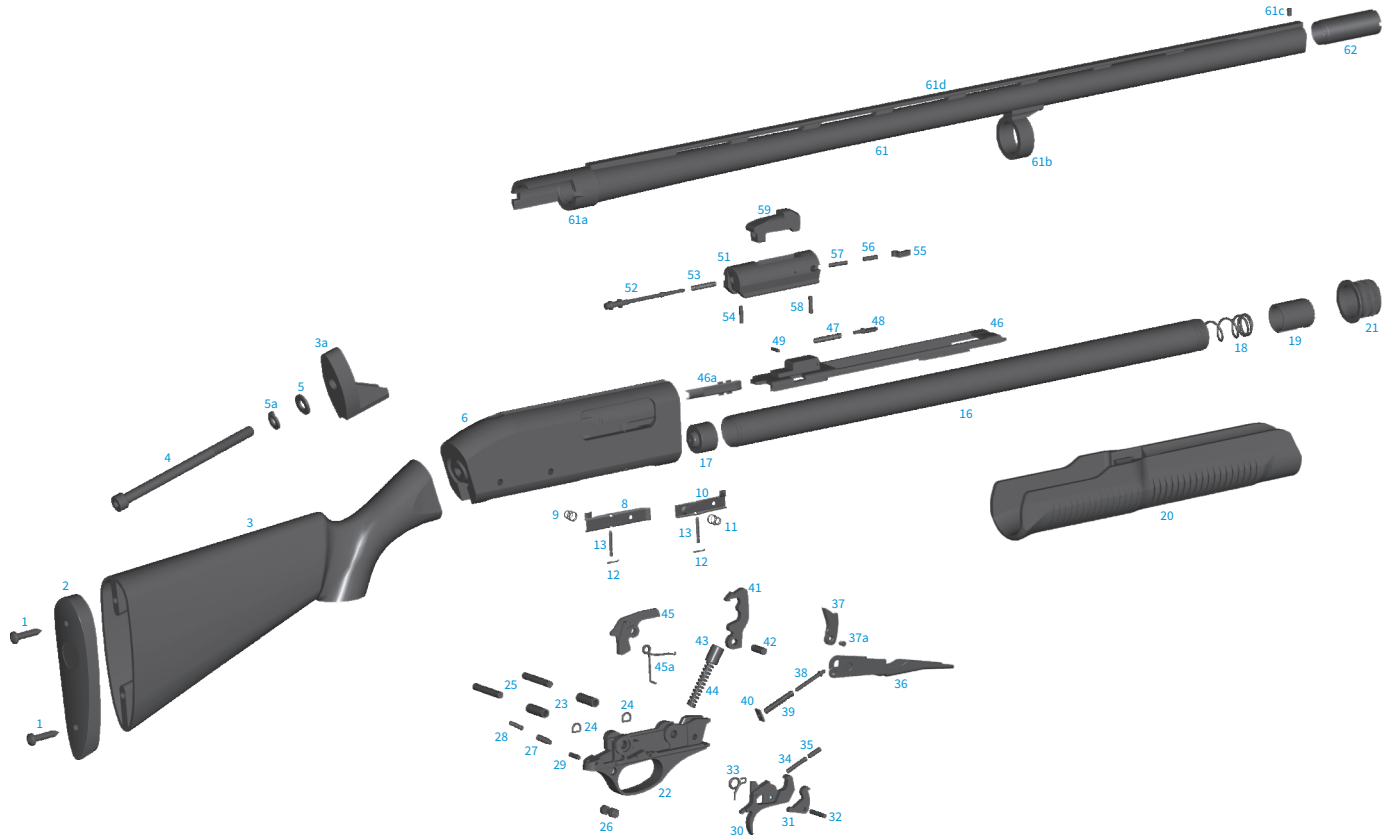

MODELS 620 - 628 PUMP SHOTGUN PART DIAGRAM

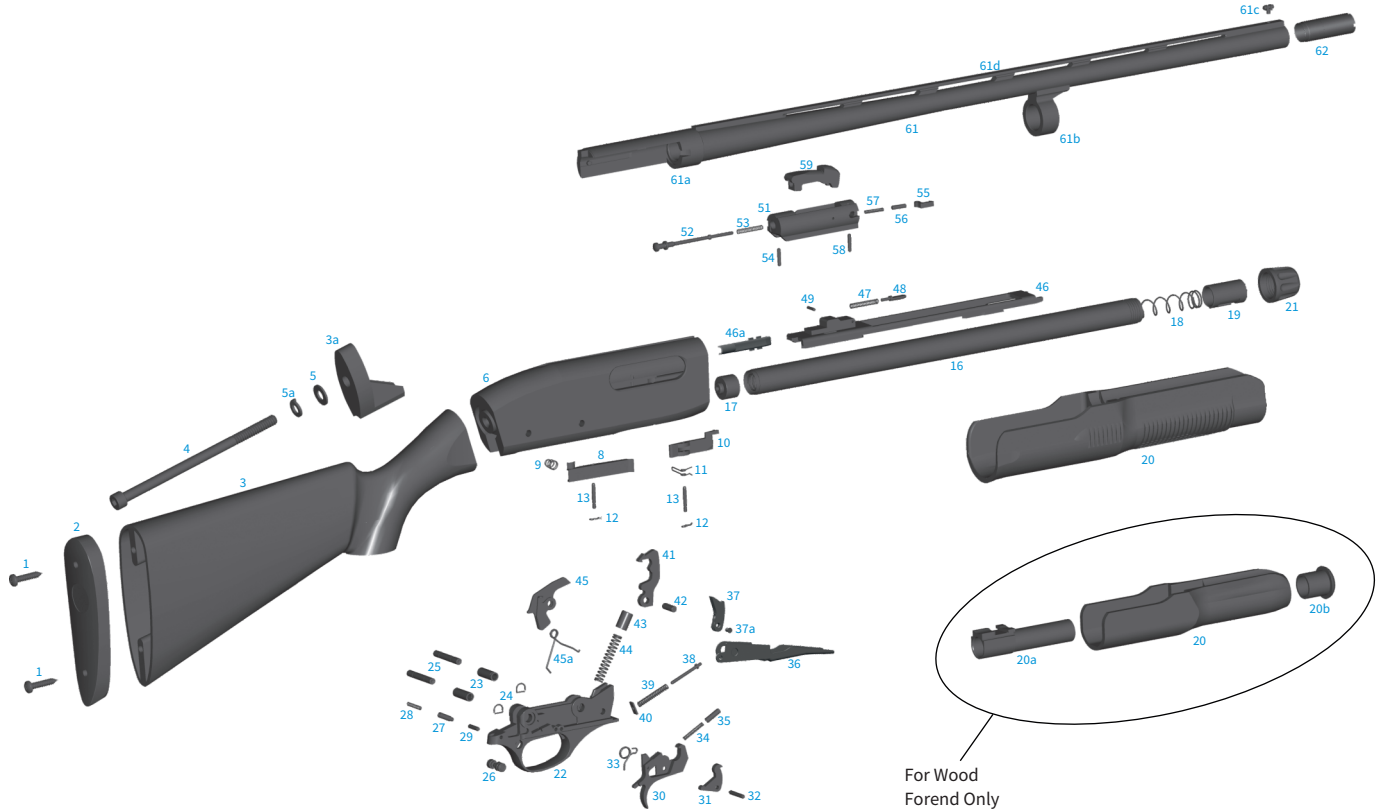

MODELS 612 - 620 - 628 PUMP SHOTGUN PART LIST

NO	PART NAME	NO	PART NAME	NO	PART NAME
1	Recoil Pad Screw (x2)	24	Trigger Plate Pin Detent Spring (x2)	45	Action Release
2	Recoil Pad	25	Trigger Plate Pin (x2)	45a	Release Latch Spring
3	Stock	26	Safety Button	46	Action Bar
3a	Stock Inner Frame	27	Safety Button Detent Pin	46a	Ejector
4	Stock Screw	28	Safety Button Spring	47	Action Bar Plunger Spring
5	Stock Screw Washer	29	Safety Spring Retaining Pin	48	Action Bar Plunger
5a	Washer Stopper	30	Trigger	49	Action Bar Plunger Retaining Pin
6	Receiver	31	Trigger Sear	51	Breech Bolt
8	Latch	32	Trigger Pin	52	Firing Pin
9	Latch Spring	33	Trigger Spring	53	Firing Pin Spring
10	Interceptor Latch	34	Trigger Sear Detent Spring	54	Firing Pin Retaining Pin
11	Interceptor Latch Spring	35	Trigger Sear Detent Pin	55	Extractor
12	Latch Pin Detent Spring (x2)	36	Carrier	56	Extractor Plunger
13	Latch Pin (x2)	37	Carrier Dog	57	Extractor Spring
16	Magazine Tube	37a	Carrier Dog Pin	58	Extractor Pin
17	Magazine Follower	38	Carrier Dog Follower	59	Locking Block
18	Magazine Spring	39	Carrier Dog Follower Spring	61	Barrel
19	Magazine Spring Retainer	40	Carrier Dog Follower Plate	61a	Barrel Rear Part
20	Forend	41	Hammer	61b	Barrel Collar
20a	Action Bar Sleeve	42	Hammer Pin	61c	Front Sight
20b	Action Bar Sleeve Nut	43	Hammer Plunger	61d	Top Ventilated Rib
21	Magazine Cap	44	Hammer Spring	62	Mobile Choke
22	Trigger Plate				
23	Trigger Plate Pin Bushing (x2)				

(For Wood
Forend Only)

MODEL 636 PUMP SHOTGUN PART LIST

NO	PART NAME	NO	PART NAME	NO	PART NAME
1	Recoil Pad Screw	24	Trigger Plate Pin Detent Spring (x2)	45	Action Release
2	Recoil Pad	25	Trigger Plate Pin (x2)	45a	Release Latch Spring
3	Stock	26	Safety Button	46	Action Bar
3a	Stock Inner Frame	27	Safety Button Detent Pin	49	Action Bar Plunger Retaining Pin
4	Stock Screw	28	Safety Button Spring	51	Breech Bolt
5	Stock Screw Washer	29	Safety Spring Retaining Pin	52	Firing Pin
6	Receiver	30	Trigger	53	Firing Pin Spring
12	Latch Pin Detent Spring	31	Trigger Sear	54	Firing Pin Retaining Pin
13	Latch Pin	32	Trigger Pin	55	Extractor
16	Magazine Tube	33	Trigger Spring	56	Extractor Plunger
17	Magazine Follower	34	Trigger Sear Detent Spring	57	Extractor Spring
18	Magazine Spring	35	Trigger Sear Detent Pin	58	Extractor Pin
19	Magazine Spring Retainer	36	Carrier	61	Barrel
20	Forend	37	Carrier Dog	61a	Barrel Rear Part
21	Magazine Cap	37a	Carrier Dog Pin	61b	Barrel Collar
21a	Magazine Cap Sling Stud	38	Carrier Dog Follower	61c	Front Sight
21b	Magazine Cap Sling Stud Nut	39	Carrier Dog Follower Spring	61d	Top Ventilated Rib
22	Trigger Plate	40	Carrier Dog Follower Plate	62	Mobile Choke
23	Trigger Plate Pin Bushing (x2)	41	Hammer	63a	Latch
		42	Hammer Pin	63b	Latch Spring
		43	Hammer Plunger	63c	Latch Tip
		44	Hammer Spring	63d	Latch Tip Spring
				63e	Latch Tip Pin
				63f	Stock Sling Stud

MODEL 612 TAC PUMP SHOTGUN PART DIAGRAM

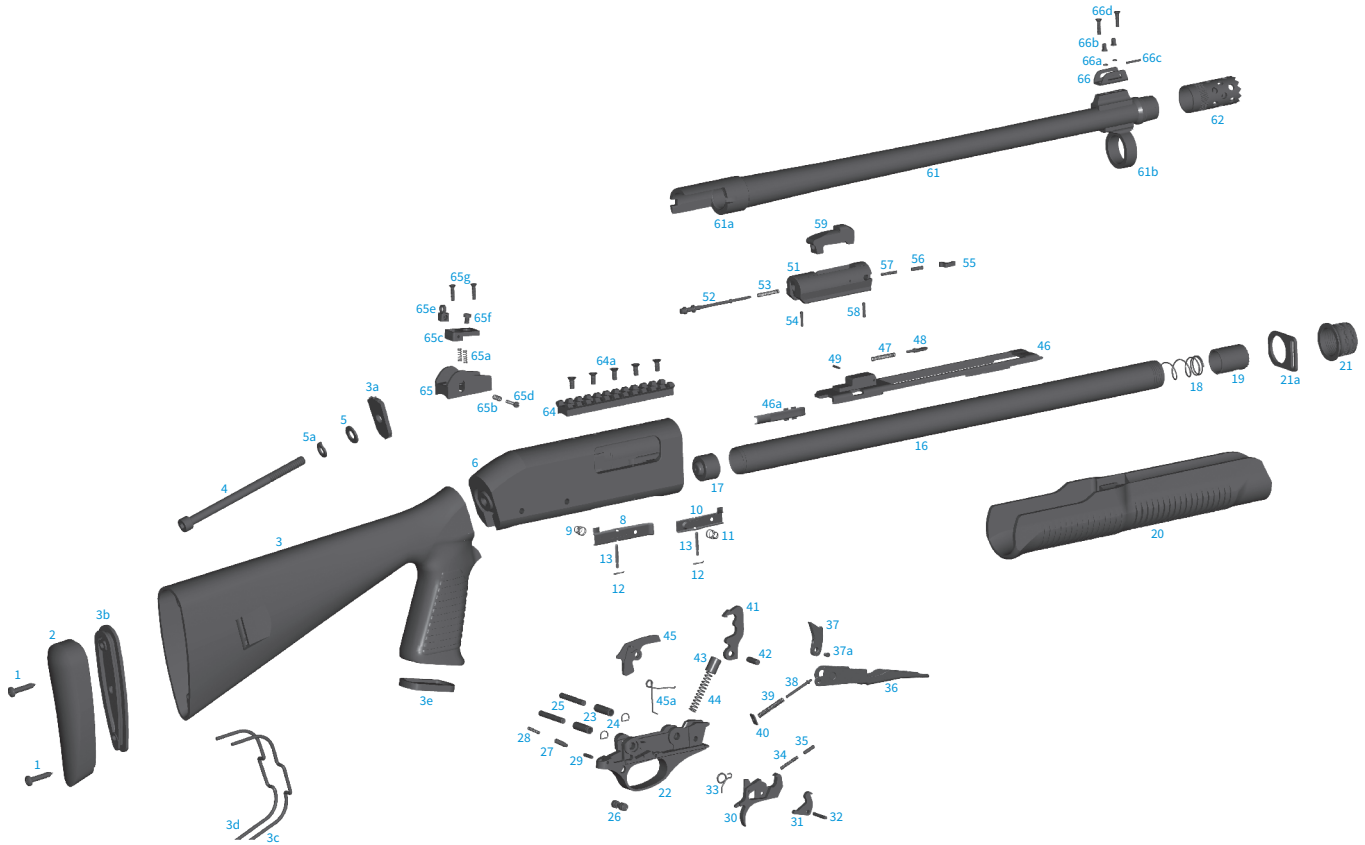

MODEL 612 TAC PUMP SHOTGUN PART LIST

NO	PART NAME	NO	PART NAME	NO	PART NAME
1	Recoil Pad Screw (x2)	25	Trigger Plate Pin (2)	52	Firing Pin
2	Recoil Pad	26	Safety Button	53	Firing Pin Spring
3	Stock	27	Safety Button Detent Pin	54	Firing Pin Retaining Pin
3a	Stock Connection Part	28	Safety Button Spring	55	Extractor
3b	Recoil Pad	29	Safety Spring Retaining Pin	56	Extractor Plunger
3c	Sling Attachment R.H.	30	Trigger	57	Extractor Spring
3d	Sling Attachment L.H.	31	Trigger Sear	58	Extractor Pin
3e	Stock Bottom Cap	32	Trigger Pin	59	Locking Block
4	Stock Screw	33	Trigger Spring	61	Barrel
5	Stock Screw Washer	34	Trigger Sear Detent Spring	61a	Barrel Rear Part
5a	Washer Stopper	35	Trigger Sear Detent Pin	61b	Barrel Collar
6	Receiver	36	Carrier	62	Mobile Choke Tube
8	Latch	37	Carrier Dog	64	Picatinny Rail
9	Latch Spring	37a	Carrier Dog Pin	64a	Picatinny Rail Screw (x4)
10	Interceptor Latch	38	Carrier Dog Follower	65	Rear Sight
11	Interceptor Latch Spring	39	Carrier Dog Follower Spring	65a	Rear Sight Spring (x2)
12	Latch Pin Detent Spring	40	Carrier Dog Follower Plate	65b	Rear Sight Adjustment Spring
13	Latch Pin	41	Hammer	65c	Rear Sight Plate
16	Magazine Tube	42	Hammer Pin	65d	Rear Sight Horizontal Adjusting Screw
17	Magazine Follower	43	Hammer Plunger	65e	Rear Sight Ring
18	Magazine Spring	44	Hammer Spring	65f	Rear Sight Vertical Adjusting Screw
19	Magazine Spring Retainer	45	Action Release	65g	Rear Sight Screw (x2)
20	Forend	45a	Release Latch Spring	66	Front Sight Upper Part
21	Magazine Cap	46	Action Bar	66a	Front Sight O Ring (x2)
21a	Sling attachment	46a	Ejector	66b	Front Sight Fiber Optic Holder (x2)
22	Trigger Plate	47	Action Bar Plunger Spring	66c	Front Sight Fiber Optic
23	Trigger Plate Pin Bushing (x2)	48	Action Bar Plunger	66d	Front Sight Screw (x2)
24	Trigger Plate Pin Detent Spring (x2)	49	Action Bar Plunger Retaining Pin		
		51	Breech Bolt		



AKKAR SİLAH SANAYİ LTD

ORHANLI MH ANIT SK 21 TUZLA 34956 İSTANBUL TURKEY

P +90 216 394 43 64 **F** +90 216 394 43 73

AKKAR@AKKAR.COM.TR WWW.AKKAR.COM.TR



//AKKARSILAH



@AKKARSILAH



//AKKARSILAH

HMC.KLV.POMP.010-00